

# LED Tail Lights - Model 234

## PRODUCT INFORMATION

<b>Description</b>	12-24V DOT LED Heated Red Stop, Tail, & Turn Light
<b>Height</b>	20.28 mm / 0.8 in
<b>Width</b>	110.14 mm / 4.34 in
<b>Depth</b>	39.53 mm / 1.56 in
<b>Shape</b>	Round
<b>Outer Lens Material</b>	Polycarbonate
<b>Outer Lens Color</b>	Clear
<b>Housing Material</b>	Polycarbonate
<b>Housing Color</b>	Black
<b>Bezel Color</b>	Red
<b>Mounting Type</b>	Grommet
<b>Connector or Wiring</b>	Bare Leads
<b>Mating Connector</b>	None. 3-Pin AMP Connector (#282087-1) sold separately.
<b>Product Weight</b>	0.31 lbs / 0.14 kgs
<b>Shipping Weight</b>	0.48 lbs / 0.22 kgs
<b>Additional Information</b>	Power supplied in any mode will power the heater. If power is not supplied to the heater, the light will not be heated. Turn off power before installing.



Print date: 2024-08-11

© 2024 J.W. Speaker Corporation • Germantown, WI U.S.A.  
www.jwspeaker.com • speaker@jwspeaker.com • 262.251.6660

**J.W. SPEAKER**  
Engineered. Lighting. Solutions.

# LED Tail Lights - Model 234

## PRODUCT DIMENSIONS

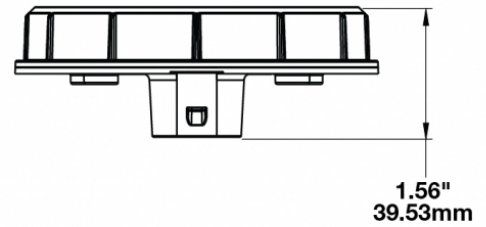
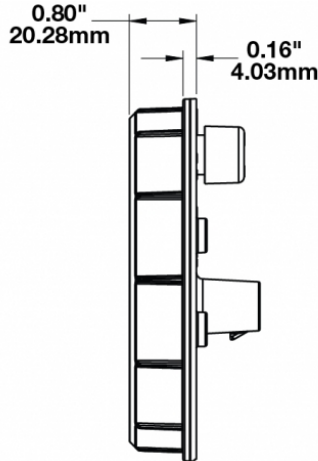
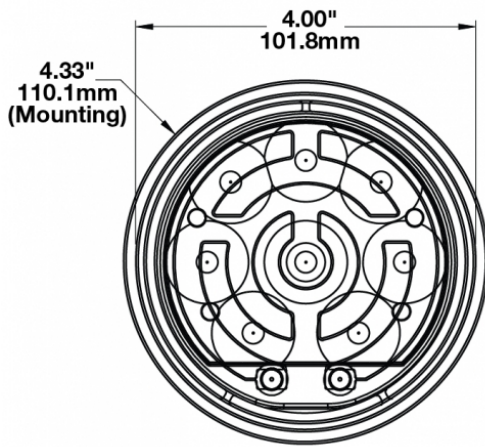

### Pin Out Information

LIGHT (Socket shown ↑ top)

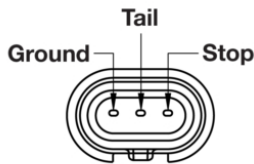

### WIRE HARNESS\*

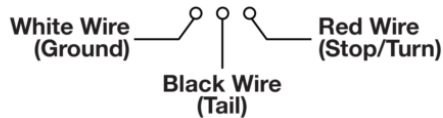

\*Wire harness sold separately on Part # 0346261.  
Wire harness included on Part # 0346264.  
Also available as a single accessory (Part # 3270501)

Print date: 2024-08-11

© 2024 J.W. Speaker Corporation • Germantown, WI U.S.A.  
www.jwspeaker.com • speaker@jwspeaker.com • 262.251.6660

# LED Tail Lights - Model 234

## ELECTRICAL SPECIFICATIONS

<b>Input Voltage</b>	12-24V DC
<b>Operating Voltage</b>	9-32V DC
<b>Current Draw</b>	.03A @ 12V DC (Tail) .02A @ 24V DC (Tail) .17A @ 12V DC (Turn / Stop) .12A @ 24V DC (Turn / Stop) .80A @ 12V DC (Tail Heated) .40A @ 24V DC (Tail Heated) 1.0A @ 12V DC (Turn / Stop Heated) .50A @ 24V DC (Turn / Stop Heated) .80A @ 12V DC (Heater) .40A @ 24V DC (Heater)

## REGULATORY STANDARDS COMPLIANCE

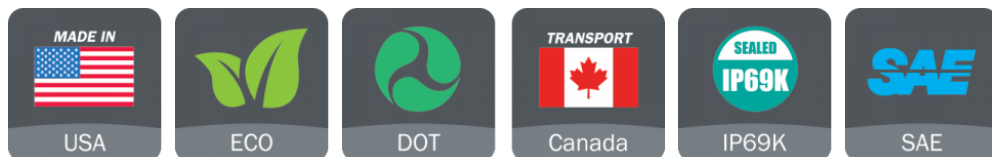

Buy America Standards	Eco Friendly
FMVSS 108 s7.1 (Table VII)	FMVSS 108 s7.2 (Table VIII)
FMVSS 108 s7.3 (Table IX)	IEC IP69K
SAE J585	SAE J586
SAE J588	

## PHOTOMETRIC SPECIFICATIONS

<b>Effective Lumen Output</b>	54
<b>Beam Pattern(s)</b>	Signalization - Tail Signalization - Turn (Rear)

Print date: 2024-08-11

© 2024 J.W. Speaker Corporation • Germantown, WI U.S.A.  
www.jwspeaker.com • speaker@jwspeaker.com • 262.251.6660

**J.W. SPEAKER**  
Engineered. Lighting. Solutions.

# LED Tail Lights - Model 234

## APPLICATIONS

---



## SMARTHEAT™ HEATING SYSTEM

---

The SmartHeat™ heating system senses ambient temperature and turns the integrated heating system in the lens on & off. This system actually clears ice & snow twice as fast as conventional halogen lamps.

### When does the heater turn on?

Heater turns on or off according to temperature changes and vehicle power:

- Heater will turn on when temperatures drop, generating enough heat to prevent ice build-up.
- Heater will turn on when powering up, de-icing the light as rapidly as possible.

### When does the heater turn off?

Heater will turn off when it senses temperatures increase and are above the high temperature threshold.

Learn more about this technology [here](#).

See Additional Information on page 1 for heated wire installation

## PRODUCT WARNINGS

---

For California residents:

**⚠ WARNING:** Cancer and reproductive harm - [www.P65Warnings.ca.gov](http://www.P65Warnings.ca.gov).

**⚠ AVERTISSEMENT:** Cancer et effet nocif sur la reproduction - [www.P65Warnings.ca.gov](http://www.P65Warnings.ca.gov).

---

Print date: 2024-08-11

© 2024 J.W. Speaker Corporation • Germantown, WI U.S.A.  
www.jwspeaker.com • speaker@jwspeaker.com • 262.251.6660

**J.W. SPEAKER**  
Engineered. Lighting. Solutions.

# LED Tail Lights - Model 234

## ACCESSORIES



**Part Number**  
**4242731**  
4" Round Rubber  
Mounting Grommet for  
Model 234



**Part Number**  
**5869401**  
4" Round Plastic  
Mounting Flange for  
Model 234

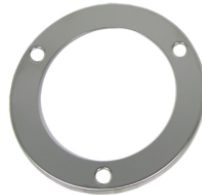

**Part Number**  
**8200441**  
4" Round Stainless  
Steel Trim Ring for  
Model 234



**Part Number**  
**8200451**  
4" Round Chrome  
Plastic Trim Ring for  
Model 234



**Part Number**  
**3270501**  
3-Pin AMP Connector  
Wire Harness  
Assembly

## RELATED PRODUCTS



**Part Number**  
**0346264**  
12-24V DOT LED  
Heated Red Stop, Tail,  
& Turn Light Kit with  
Harness



**Part Number**  
**0346421**  
12-48V DOT LED Non-  
Heated Stop & Tail  
Light



**Part Number**  
**0346471**  
12-24V DOT LED  
Heated White Reverse  
Light



**Part Number**  
**0346474**  
12-24V DOT LED  
Heated White Reverse  
Light Kit with Harness



**Part Number**  
**0347811**  
12-24V DOT LED  
Heated Amber Turn  
Signal



**Part Number**  
**0347814**  
12-24V DOT LED  
Non-Heated Red Stop,  
Tail, & Turn Light Kit  
with Harness



**Part Number**  
**0347861**  
12-24V DOT LED Non-  
Heated Red Stop, Tail,  
& Turn Light



**Part Number**  
**0347864**  
12-24V DOT LED Non-  
Heated Red Stop, Tail,  
& Turn Light Kit with  
Harness

Print date: 2024-08-11

© 2024 J.W. Speaker Corporation • Germantown, WI U.S.A.  
www.jwspeaker.com • speaker@jwspeaker.com • 262.251.6660

**J.W. SPEAKER**  
Engineered. Lighting. Solutions.